

型号 Type :

13M/M-3/5/11V



■ 产品特征 FEATURES:

- 高可靠性和高稳定性

High intensity and reliability

- 高品质、和低功耗、低成本

High quality, Low power requirement and low cost

- IC 易兼容、易装配

IC compatible , Easy assembly

- 符合 RoHS 指令要求

Meet RoHS EU Directive

- 静电承受能力 2000V

ESD 2000V

■ 产品描述 DESCRIPTION:

- 数码管

Display

- 极性共阳

Common Anode

- 白面, 白胶

white face, white segment

- 发光颜色

Luminous Color:

1、黄绿色 Y/GREEN

2、

3、

4、

5、

- 晶片材质

Chips Materials

1、AlGaInP

2、

3、

4、

5、

型号 Type :

13M/M-3/5/11V



■ 产品最大绝对参数值 (Ta: 25°C) ABSOLUTE MAXIMUM RATINGS AT Ta=25°C :

PARAMETER 项目	SYMBOL 符号	Y/GREEN 黄绿色	UNIT 单位
Power Dissipation Per Segment 功耗	PAD	50	mw
Reverse Voltage Per Segment 反向耐压	VR	5	V
Continuous Forward Current Per Segment 最大使用电流	IAF	20	mA
Peak Forward Current Per Segment(Duty-0.1,1KHz) 最大峰值电流	IPF	60	mA
Operating Temperature Range 工作温度	TOPr	-20°C to 80°C	
Storage Temperature Range 贮藏温度	Tstg	-30°C to 85°C	
Lead Soldering Temperature 260°C at 1.6mm From Body for 3 second 焊接温度 260°C/3秒 距离胶体 1.6mm 以上			

■ 产品光电参数值 (Ta: 25°C) ELECTRICAL/OPTICAL CHARACTERISTICS AT Ta=25°C :

PARAMETER 项目	SYMBOL 符号	TEST CONDITION 测试条件	Color 颜色	MIN 最小值	TYP 标准值	MAX 最大值	UNIT 单位
Forward Voltage ,Per Segment 正向压降	VF	IF=20mA	黄绿色 Y/GREEN	10	11	12.5	V
Reverse Current , Per Segment 反向漏电流	IR	VR=5V	黄绿色 Y/GREEN			50	μA
Peak Emission Wavelength 峰值波长	λp	IF=20mA	黄绿色 Y/GREEN	570	571	573	nm
Luminous Intensity Per Segment 法向光强	IV	IF=20mA	黄绿色 Y/GREEN	15	18	20	mcd

型号 Type :

13M/M-3/5/11V



Fig 1. Forward Current vs. Forward Voltage

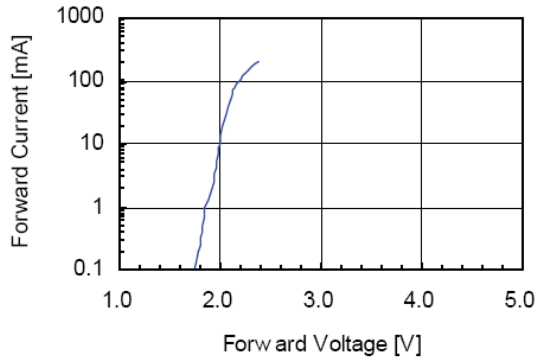

Fig 2. Relative Intensity vs. Forward Current

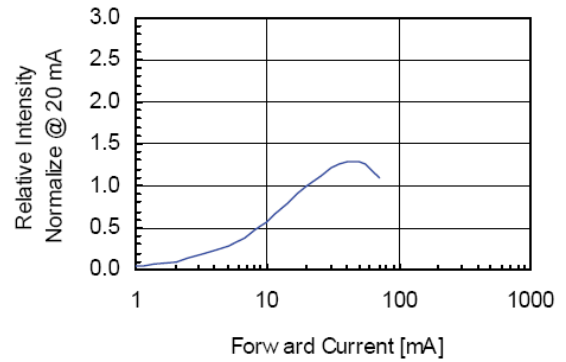

Fig 3. Forward Voltage vs. Temperature

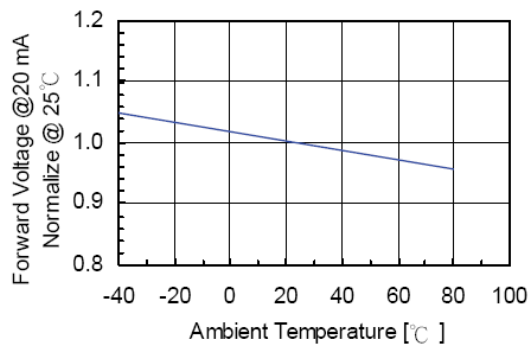

Fig 4. Relative Intensity vs. Temperature

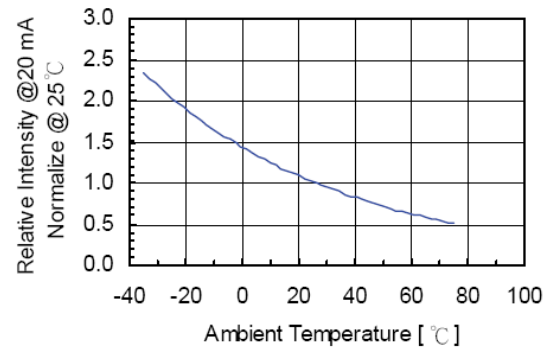
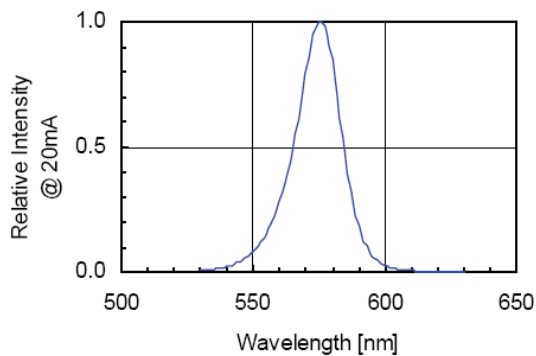
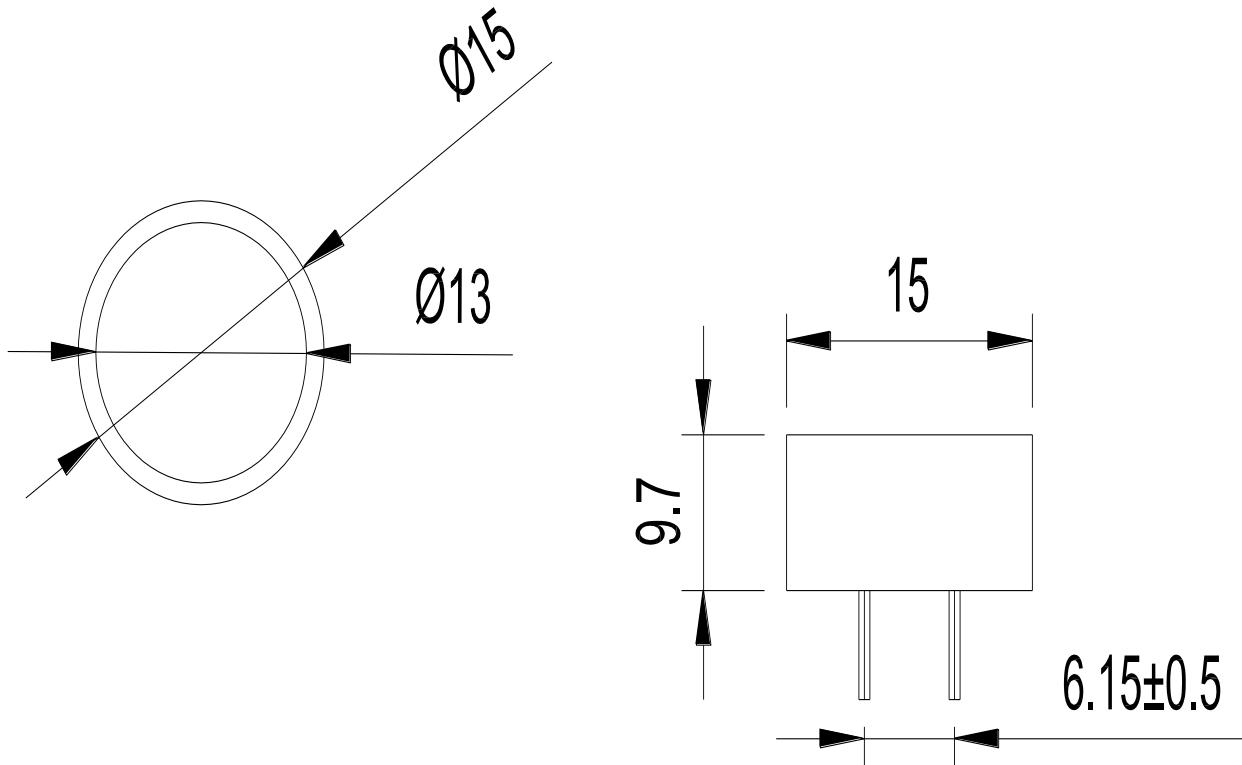

Fig 5. Relative Intensity vs. Wavelength



型号 Type :

13M/M-3/5/11V



帶色点的为正极

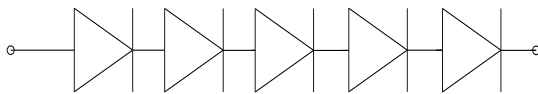

NOTES : 1. All dimensions are in millimeters. (inches)

2. Tolerance is $\pm 0.25(0.010)$ unless otherwise specified.